

ALL-ELECTRIC LEXUS UX 300e

LEXUS PRICE LIST

OCTOBER 2021



LEXUS ELECTRIFIED

Lexus have been a pioneer and leader in luxury car electrification for more than 15 years.

The UX 300e is spearheading the next chapter of electrification at Lexus. Created to evoke the original fun of driving in the city, the UX 300e combines world-class Lexus refinement with an exciting new Lexus Electrified experience.

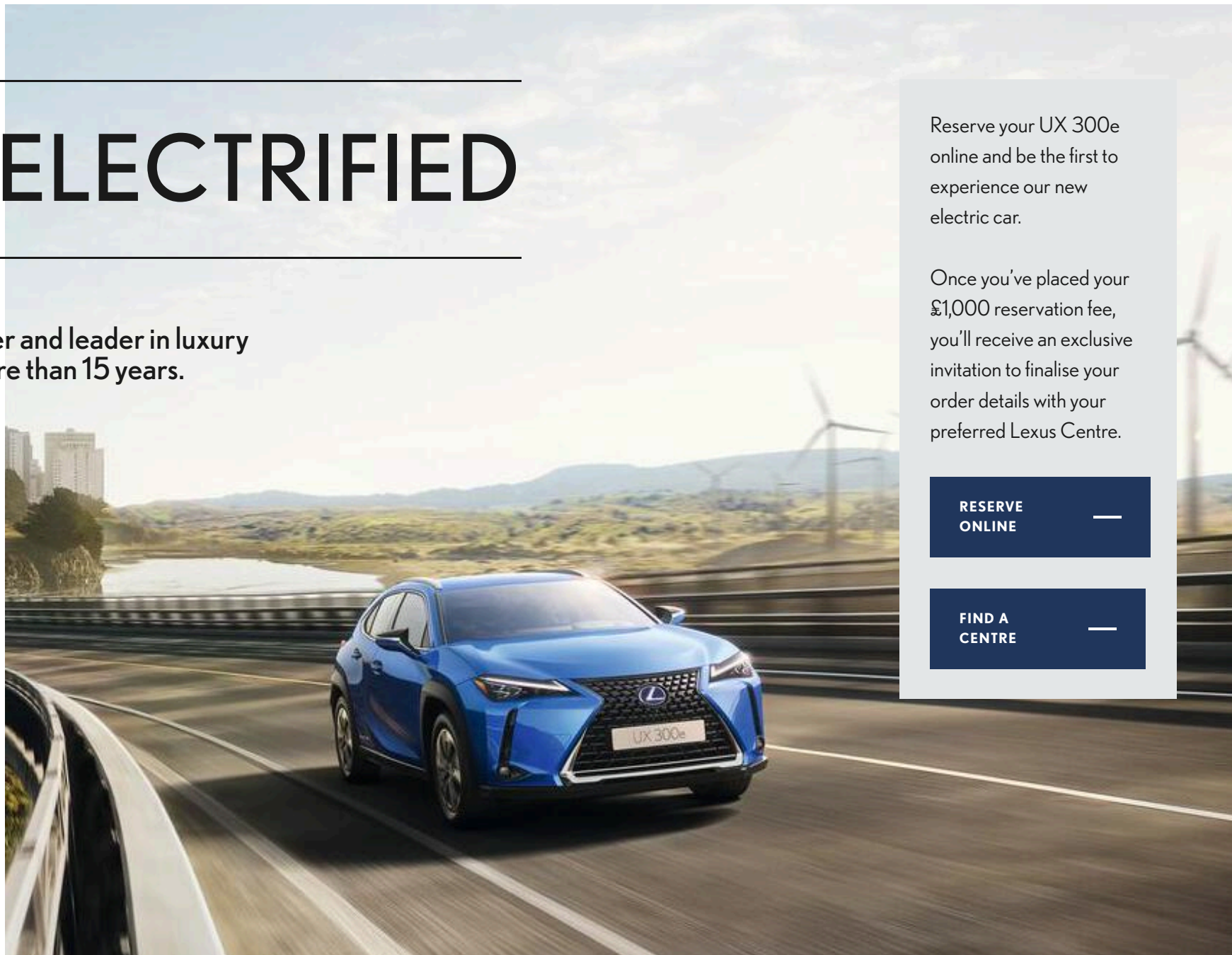

Reserve your UX 300e online and be the first to experience our new electric car.

Once you've placed your £1,000 reservation fee, you'll receive an exclusive invitation to finalise your order details with your preferred Lexus Centre.

[RESERVE
ONLINE](#)

[FIND A
CENTRE](#)

EQUIPMENT



UX 300e

Begin tailoring UX 300e to your requirements by exploring standard specifications.

Equipment Highlights:

- 17" Alloy Machine Finish Wheels with Tyre Repair Kit
- Lexus Safety System +
- Bi-LED Headlights with Auto High Beam (AHB)
- Reversing Camera with Back Guidelines
- Intelligent Front and Rear Parking Sensors
- Premium Fabric Upholstery
- Japanese 'Washi' Paper Inspired Instrument Panel
- 8-Way Electrically Adjustable Front Seats
- Electrically Adjustable, Foldable and Heated Door Mirrors
- 2-Way Power Lumbar Support
- Power Adjustable Steering Wheel
- 7" Multimedia screen with Remote Touch Interface
- 6-Speaker Audio System with USB, AUX Input and Bluetooth® Connectivity
- Lexus Link Connected Services
- Apple CarPlay® and Android Auto®
- Type 2 and Domestic 3-pin AC Charging Cables
- AC and DC Charging Ports



UX 300e PREMIUM PLUS PACK

Add a little bit of luxury to make driving your UX 300e even more of a pleasure.

Equipment Highlights (in addition to UX 300e):

- Smart Keyless Entry
- Card Key
- Illuminated Door Handles with Puddle Light
- Smooth Leather Upholstery
- Heated and Ventilated Front Seats
- Heated Rear Seats
- Heated Steering Wheel
- Wireless Smartphone Charger
- Privacy Glass

Options:

- 18" Alloy Wheels with tyre repair kit and Aluminium Scuff Plates



Premium Plus Pack with 18" wheels

UX 300e TAKUMI PACK

Add a little bit of luxury to make driving your UX 300e even more of a pleasure.

Equipment Highlights (in addition to UX 300e Premium Plus Pack):

- 3-Eye LED Headlights with Adaptive High Beam System (AHS)
- Blind Spot Monitor (BSM)
- Rear Cross Traffic Alert with Auto Brake (RCTAB)
- Hands-free Power Back Door with Kick Sensor
- 360° Panoramic View Monitor
- Head-Up Display (HUD)
- 10.3" Lexus Navigation
- 13-Speaker Mark Levinson® Premium Surround Sound System
- Auto-dimming Interior Rear View Mirror
- Sunroof
- Aluminium Scuff Plates
- Auto folding door mirrors with reverse tilt function



COLOURS AND TRIMS



INTERIOR COLOURS AND TRIMS

Seat Colour	Seat Material	Dashboard	Pillars	Roof	Code	UX 300e	UX 300e with Premium Plus Pack	UX 300e with Takumi Pack
Black	Premium Fabric	Black	Black	Black	FA20	○	-	-
Cobalt	Premium Fabric	Blue	Black	White	FA80	○	-	-
Rich Cream	Smooth Leather	Noble brown	Black	White	LA00	-	○	○
White Ash	Smooth Leather	Black	Black	Black	LA10	-	○	○
Black	Smooth Leather	Black	Black	Black	LA20	-	○	○
Ochre	Smooth Leather	Black	Black	White	LA41	-	○	○
Cobalt	Smooth Leather	Blue	Black	White	LA80	-	○	○

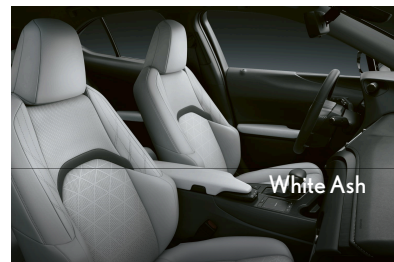
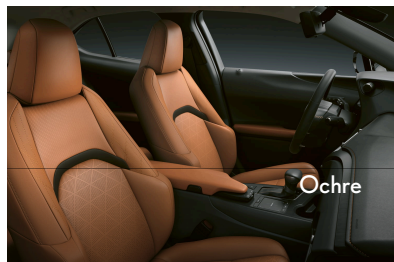









○ : Available - : Not available

See the full list of features available in the UX 300e.

[CONFIGURE YOUR UX 300E](#)

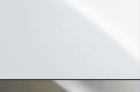
EXTERIOR COLOURS

Type	Colour		Code	All Options	OTR
Solid	Velvet Black		212	○	£0
	Fuji Red		3T2	○	
Metallic	Mercury Grey		1H9	○	£570
	Satin Silver		1J4	○	
	Graphite Black		223	○	
	Terrane Khaki		6X4	○	
	Celestial Blue		8Y6	○	
Special Metallic	Sonic White		085	○	£820
	Sonic Titanium		1J7	○	
	Blazing Carnelian		4Y1	○	



See the full list of features in the UX 300e brochure.

[VIEW THE FULL BROCHURE](#)

○ : Available - : Not available

FULL PRICE LIST



UX 300e

UX 300e

Grade	Packs and Options	Transmission	CO ₂ g/km (WLTP)	VED band	BIK % 21/22	Basic Price	VAT	Delivery	Number Plates	List Price (P11D)	VED	First Registration Fee	OTR
UX		Single Speed Transaxle	0	A	1%	£34,136.67	£6,827.33	£700.00	£26.00	£41,690.00	£0.00	£55.00	£41,745.00
	Premium Plus Pack	Single Speed Transaxle	0	A	1%	£37,053.33	£7,410.67	£700.00	£26.00	£45,190.00	£0.00	£55.00	£45,245.00
	Premium Plus Pack with 18" Wheels	Single Speed Transaxle	0	A	1%	£37,678.33	£7,535.67	£700.00	£26.00	£45,940.00	£0.00	£55.00	£45,995.00
	Takumi Pack	Single Speed Transaxle	0	A	1%	£42,136.67	£8,427.33	£700.00	£26.00	£51,290.00	£0.00	£55.00	£51,345.00



To see the latest offers for UX 300e please visit our website by clicking the button below.

[VIEW OFFERS](#)

UX FULL SPECIFICATION



ACTIVE SAFETY AND DRIVING DYNAMICS

	UX 300e	UX 300e with Premium Plus Pack	UX 300e with Takumi Pack
Vehicle Dynamics Integrated Management (VDIM)	■	■	■
Anti-lock Braking System (ABS)	■	■	■
Brake Assist System (BAS)	■	■	■
Traction Control (TRC)	■	■	■
Electronic Brake force Distribution (EBD)	■	■	■
Vehicle Stability Control (VSC)	■	■	■
Electronically Controlled Brake System (ECB)	■	■	■
Electric Power Steering (EPS), speed sensitive	■	■	■
Secondary Collision Brake (SCB)	■	■	■
Hill Start Assist Control (HAC)	■	■	■
Electronic parking brake (EPB)	■	■	■
NEW Lexus Safety System+ consisting of: - Dynamic Radar Cruise Control (DRCC) - Pre-Collision System (PCS) Day & Night - Lane Tracing Assist (LTA) - Road Sign Assist (RSA) - Automatic High Beam (AHB)	■	■	■
Adaptive High Beam System (AHS)- replaces AHB	-	-	■
E-Call	■	■	■
Blind Spot Monitor (BSM) with Rear Cross Traffic Alert and Auto-Brake (RCTAB)	-	-	■
3 driving modes: Normal, Eco & Sport	■	■	■
Front and rear suspension performance dampers	■	■	■
Active Sound Control (ASC)	■	■	■
Tyre Pressure Warning System (TPWS)	■	■	■

PASSIVE SAFETY

	UX 300e	UX 300e with Premium Plus Pack	UX 300e with Takumi Pack
Driver and front passenger 2-stage airbag	■	■	■
Driver & passenger's knee airbag	■	■	■
Driver and front passenger side airbags	■	■	■
Curtain shield airbags (front and rear)	■	■	■
Front passenger airbag cut-off switch	■	■	■
Front seat belt with pre-tensioners, force limiter and tension reduction: 3-point with active safety link to PCS.	■	■	■
Rear outer seat belt with pre-tensioners, force limiter and tension reduction: 3-point with active safety link to PCS. Centre belt w/o pre tensioner and force limiter	■	■	■
Front adjustable seat belt anchor points	■	■	■
2 x ISOFIX child rear seat restraints	■	■	■

RESERVE ONLINE

FIND A CENTRE

■: Available as standard

○: Available as an option

-: Not Available

SECURITY

	UX 300e	UX 300e with Premium Plus Pack	UX 300e with Takumi Pack
Anti-theft system: alarm, intrusion sensor, glass breakage sensor and engine immobiliser	■	■	■
Two motion door lock: double lock	■	■	■
Speed sensitive auto door lock	■	■	■
VIN etching	■	■	■
2 x remote key fobs	■	■	■
Card key	-	■	■
Locking wheel nuts (Thatcham approved)	■	■	■

INTERIOR COMFORT AND CONVENIENCE

	UX 300e	UX 300e with Premium Plus Pack	UX 300e with Takumi Pack
Push button start	■	■	■
Smart Keyless Entry	-	■	■
Reversing Camera with guidelines	■	■	■
360° Panoramic View Monitor	-	-	■
Dual zone climate control air conditioning system with Nano-E humidity sensor	■	■	■
Rear air vents	■	■	■
Auto-dimming interior rear view mirror	-	-	■
Leather steering wheel with paddle shifters	■	■	■
Power adjustable steering wheel	■	■	■
Heated steering wheel	-	■	■
Leather gear lever	■	■	■
LED interior illumination	■	■	■
Aluminium scuff plates	-	○	■
Japanese Washi paper inspired instrument panel	■	■	■
Analogue Lexus clock with GPS	■	■	■
4 x tie down hooks in boot	■	■	■
2 x folding shopping bag hooks in boot	■	■	■
2 x sun visors with vanity mirror and lamp	■	■	■
Textile carpet mats	■	■	■

■: Available as standard

○: Available as an option

-: Not Available

STORAGE

	UX 300e	UX 300e with Premium Plus Pack	UX 300e with Takumi Pack
Centre armrest with storage (4.4lt)	■	■	■
Glove box (7.2lt)	■	■	■
Storage tray under audio panel	■	■	■
2 cup holders in centre console	■	■	■
Rear armrest with 2 cup holders	■	■	■
Driver and passenger's door pockets (bottle holder)	■	■	■
Map pockets in the rear of passenger's front seat	■	■	■

SEATS

	UX 300e	UX 300e with Premium Plus Pack	UX 300e with Takumi Pack
Premium Fabric upholstery	■	-	-
Smooth leather upholstery	-	■	■
2-way power lumbar support for driver	■	■	■
8-way electrically adjustable front seats	■	■	■
Heated and ventilated front seats	-	■	■
Heated rear seats	-	■	■
60/40 split folding rear seat	■	■	■

■: Available as standard

○: Available as an option

-: Not Available

EXTERIOR

	UX 300e	UX 300e with Premium Plus Pack	UX 300e with Takumi Pack
Door mirrors: electrically adjustable, foldable and heated	■	■	-
Door mirrors: auto-folding, reverse tilt function	-	-	■
Front and rear one touch power windows, with anti-jam protection	■	■	■
Rain-sensing wipers	■	■	■
Lane change flasher function	■	■	■
Front and Rear Parking Sensors with Intelligent Clearance Sonar (ICS)	■	■	■
Hands-free power back door with Kick Sensor	-	-	■
Acoustic front windscreen (noise reduction)	-	-	■
Light green UV glass (rear door, side glass)	■	-	-
Privacy glass, rear doors and tailgate	-	■	■
Illuminated Entry system	■	■	■
Illuminated door handles with puddle light	-	■	■
Roof Rails (aluminium)	■	■	■
Sunroof	-	-	■

LIGHTS

	UX 300e	UX 300e with Premium Plus Pack	UX 300e with Takumi Pack
Bi-LED (low and highbeam) headlights with Automatic High Beam (AHB)	■	■	-
3-Eye LED headlights with Two-Stage Adaptive High Beam System (AHS)	-	-	■
LED daytime running lights	■	■	■
LED front and rear fog lights	■	■	■
LED cornering lights	-	-	■
Headlight cleaners	■	■	■

AUDIO, COMMUNICATION & INFORMATION

	UX 300e	UX 300e with Premium Plus Pack	UX 300e with Takumi Pack
Apple CarPlay® and Android Auto®	■	■	■
Lexus Link Connected Services	■	■	■
7" TFT meters	■	■	■
AM/FM and DAB Radio	■	■	■
6 speakers Audio	■	■	-
13-speaker Mark Levinson® Premium Surround Sound System with 13 speakers with Clarifi™ 2.0	-	-	■
Remote Touch Interface (Touch Pad)	■	■	■
7" multimedia display screen	■	■	-
10.3" multimedia display screen	-	-	■
Lexus Navigation	-	-	■
2 front USB ports, 2 rear USB charging points	■	■	■
1 AUX port with VTR compatibility	■	■	■
12V Accessory port centre console and luggage compartment	■	■	■
Wireless smartphone charger	-	■	■
Bluetooth® mobile phone connectivity and Audio Streaming	■	■	■
Head-Up Display (HUD)	-	-	■

■: Available as standard

○: Available as an option

-: Not Available

WHEELS

	UX 300e	UX 300e with Premium Plus Pack	UX 300e with Takumi Pack
17" alloy wheels (215/60 R17 with Tyre Repair Kit)	■	■	-
18" alloy wheels (225/50 R18 with Tyre Repair Kit)	-	○	■

CABLES

	UX 300e	UX 300e with Premium Plus Pack	UX 300e with Takumi Pack
3 Pin to Type 2 AC Charging Cable	■	■	■
Type 2, Mode 3 AC Charging Cable	■	■	■

LEXUS LINK



Lexus Link offers a range of convenient services that will enhance your UX 300e experience. Start or stop the battery charge and set-up a timer based on the lowest electricity rate, for example overnight at home. All designed to make owning an Electric car as simple as possible.

Lexus Link will also allow from the phone to set the cabin temperature well in advance of any trips. Not only is it convenient to never have to sit on a cold seat, it is also more efficient and will help to optimise the real driving range.

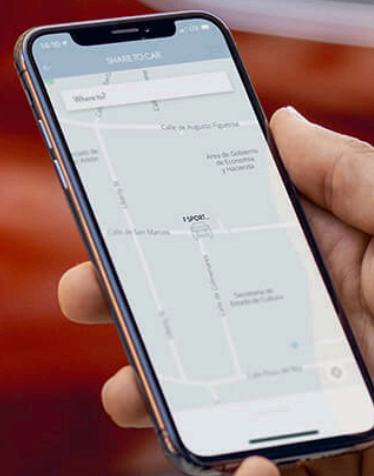

KEY FEATURES

Remote functions:

- Remotely defrost front and rear windows
- Remotely heat or cool the cabin

Battery management functions:

- Check battery status and remaining range
- Remaining charge time
- Schedule the time to start / stop charging

For the latest features consult with your Lexus Centre or visit here:

LEXUS OWNERS

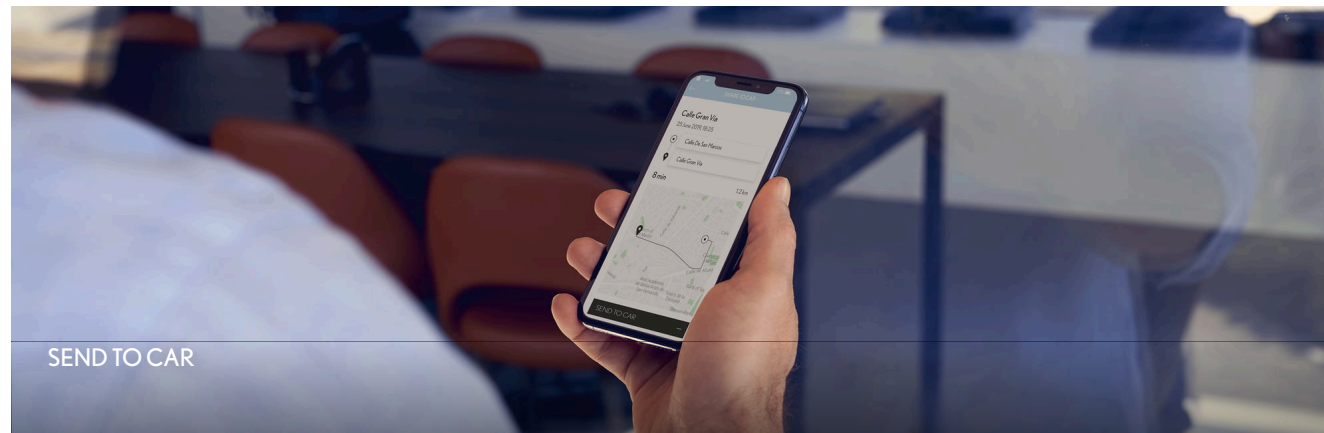
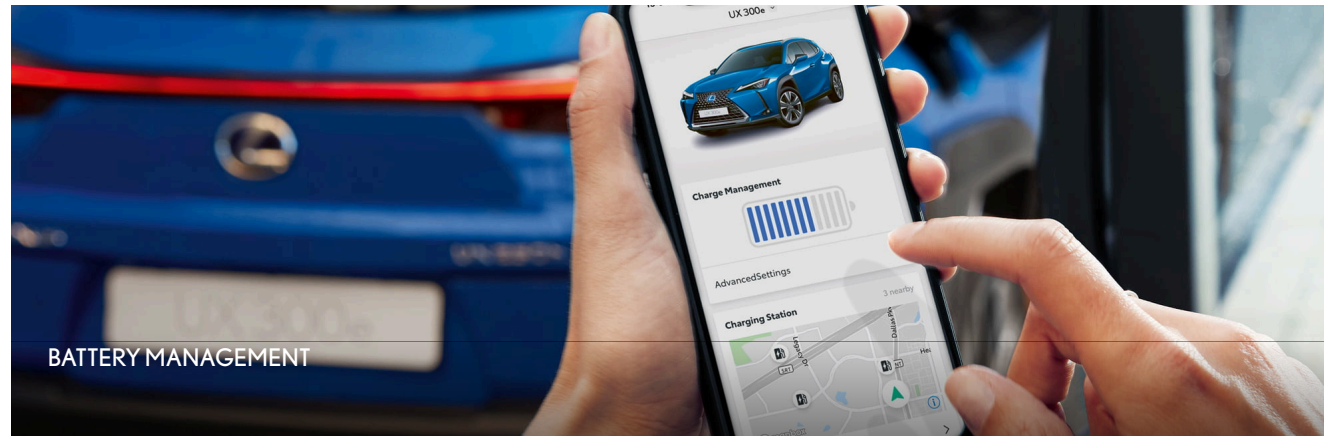

ADDITIONAL BENEFITS

UX 300e



3 YEARS' FREE LEXUS ROADSIDE ASSISTANCE

Whatever the situation, when you're driving your Lexus, we're just one call away with expert support at the roadside 24 hours a day, every day of the year.

3 years from initial purchase of new vehicle 24 hours a day, 365 days a year assistance anywhere in the UK.

Home Start

One in four breakdowns happen at the home address. Home Start allows you to enjoy all the benefits of Lexus Roadside Assistance from your home address.

Personal assistance

Lexus Roadside Assistance is designed to look after you – not just your vehicle. So even if you are a passenger in someone else's car you can still receive Lexus Roadside Assistance.

Replacement vehicle

A replacement vehicle will be provided free of charge (excluding petrol and other consumables) for up to three days, provided we have taken your vehicle to a Lexus Centre for repairs following a breakdown.

Hotel accommodation

If a replacement vehicle is unavailable, we will arrange a hotel for you and your family for up to £150 per person to a maximum of £500, for one night.

Onward travel

If a replacement vehicle is unavailable and you would like to make your own travel arrangements following a breakdown, we will reimburse the cost of this up to £150 per person, to a maximum of £500.

European travel

If you travel across Europe your Roadside Assistance will travel with you, whether you are driving your Lexus or another car.

Medical assistance

If the driver of the car is certified ill, we will take you and your passengers to any single destination in the UK.

Lost or broken keys

If you lose or break your keys, Lexus Roadside Assistance will arrange for recovery of your vehicle to a local Lexus Centre. You will be responsible, however, for the cost of replacement keys.

LEXUS RELAX UP TO 10 YEARS /100,000 MILE LEXUS WARRANTY

Every new Lexus, is eligible to be covered by up to 10 years' manufacturer warranty through Lexus Relax. This is provided through an initial 3 years manufacturer warranty that can be extended with regular servicing at a Lexus Centre. A 12 months' warranty is included with every Lexus Service, up to 100,000 miles or 10 years, whichever comes first, giving you a chance to relax in the knowledge that you and your vehicle are in safe hands. Terms and conditions apply. For full details, please ask your official LexusCentre, visit lexus.co.uk/lexus-relax/terms or search Lexus Relax.

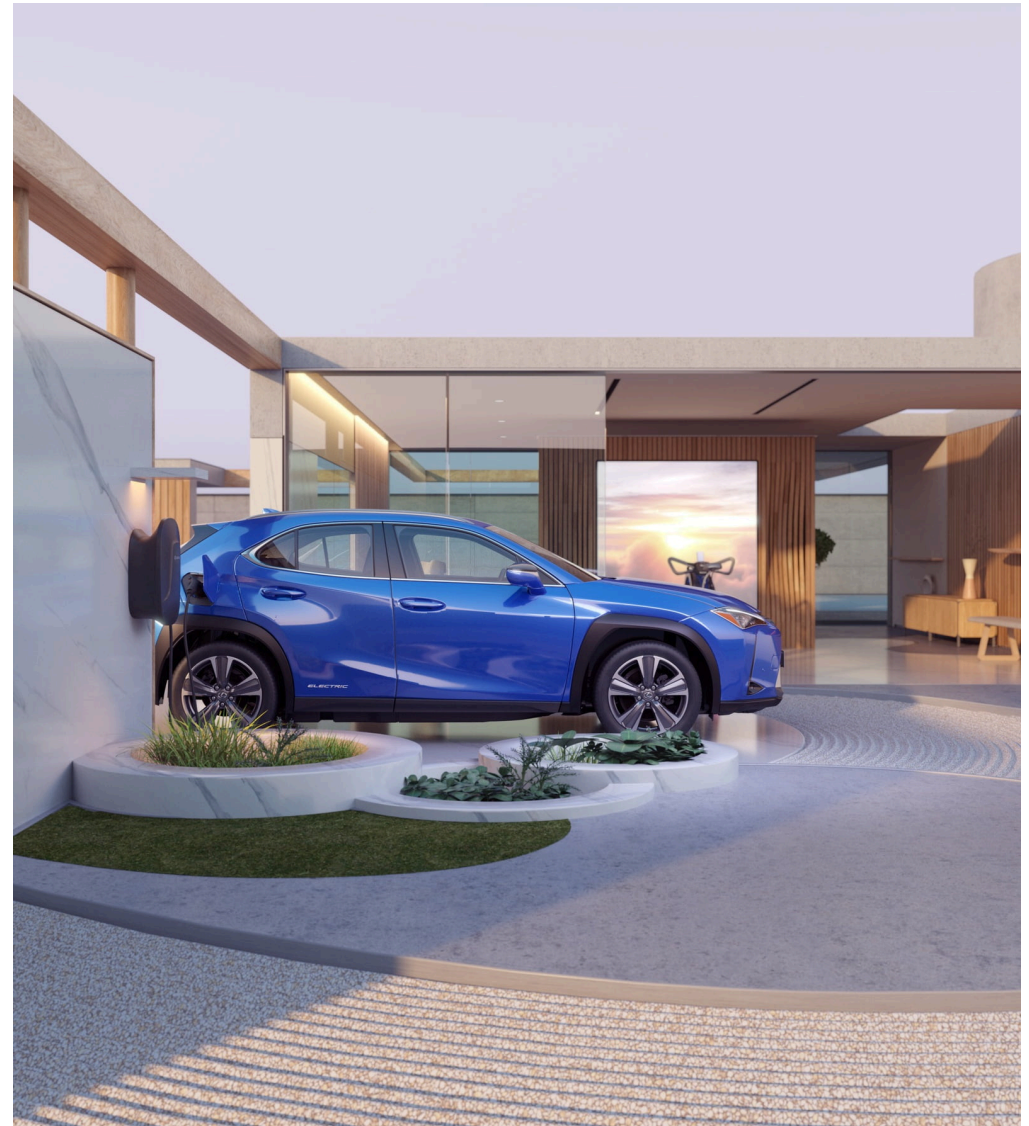

ADDITIONAL SERVICES AVAILABLE WITH UX 300e



SERVICE PLANS

A range of service plans is available. Servicing at a Lexus Centre includes added reassurance of a free EV Battery Health Check that can extend the warranty on the EV battery by an additional year or 10,000 miles up to 10 years old and 600,000 miles (whichever is soonest).



HOME WALLBOX

To support fast home charging, Lexus and Centrica-British Gas have combined to offer a national installation service. Full details available from your Lexus Centre.



ACCESSORIES



Accessory Pack	Content	UX 300e	UX 300e with Premium Plus Pack	UX 300e with Takumi Pack	Basic Price (excl. VAT)	VAT	OTR
Charging Cable	10-metre 32amp fast charge cable, Lexus storage bag included.	○	○	○	£224.17	£44.83	£269.00
Protection Pack	Rubber floor mats, boot liner, rear bumper protection film.	○	○	○	£174.17	£34.83	£209.00
Style Pack	Front underrun, rear underrun and side underrun.	○	○	○	£915.83	£183.17	£1,099.00
Design Pack	Side sills boot door trim - available in black or chrome variations.	○	○	○	£290.83	£58.17	£349.00
Aluminium scuff plates	Aluminium scuff plates with electric logo design.	○	○	-	£149.17	£29.83	£179.00
*18" Alloy Wheels	18" Gloss black machined alloy.	-	○	○	£832.50	£166.50	£999.00
*18" Alloy Wheels	18" Matt black alloy.	-	○	○			
Premium Textile Floor mats with Leather	Premium textile floor mats with leather.	○	○	○			
Roof Box	Roof box.	○	○	○			Centre fit only. Please contact your local Lexus Centre for pricing information.
Cross Bars	Cross bars.	○	○	○			
Bike holder	Bike holder.	○	○	○			

*18" Alloy wheels is only applicable to UX 300e with Premium Plus Pack with upgraded 18" Alloys.

[FOR FURTHER INFORMATION OF ACCESSORIES AVAILABLE CLICK HERE](#)

■: Available as standard ○: Available as an option -: Not Available



Protection Pack



Premium Textile Floor Mats



TECHNICAL DATA



		UX 300e
TOTAL SYSTEM OUTPUT (ENGINE AND ELECTRIC MOTOR COMBINED)	Maximum output (DIN-hp/kW)	204/150
	Maximum torque (Nm)	300
	Motor type	AC synchronous, permanent magnet
BATTERY	Type	Lithium Ion
	Number of cells	288
	Voltage	355
CHARGING RATE	AC charge (32A)	6.6kW
	DC charge (125A)	50kW
CHARGING TYPE	AC	Type 2
	DC	CHAdeMO
INDICATIVE CHARGE TIME (0-80% CAPACITY)*	UK 3-pin Plug	19 hours 45 minutes
	AC 6.6 kW	6 hours 35 minutes
	DC 50kW	52 minutes
TRANSMISSION	Type	Single Speed Transaxle
	Driven wheels	Front
PERFORMANCE	Maximum speed mph (km/h)	99 (160)
	Acceleration 0-62 mph(s)	7.5
	Driving Range (miles)	196 (17" Wheels) to 190 (18" Wheels)
INSURANCE GROUP RATING		38E

		UX 300e
ELECTRIC CONSUMPTION**	Combined (kWh/100km)	17.1 - 16.8 [^]
	Combined (kWh/10 miles)	2.75 - 2.70 [^]
DRIVING EMISSIONS	CO2 g/km Combined	0
TYRES AND WHEELS	Tyre size (front)	215/60 R17 or 225/50 R18
	Tyre size (rear)	215/60 R17 or 225/50 R18
	Wheel size	17 x 6.5J or 18 x 7J
	Tyre Repair Kit	Yes
	Tyre pressure warning system	Standard
DIMENSIONS AND WEIGHTS	Length (mm)	4495
	Width (mm)	1840
	Width (mm) with mirrors	2078
	Height (mm)	1545
	Luggage capacity to parcel shelf, rear seats up (l)	367
	Luggage capacity to the roof, rear seats up (l)	486
	Gross vehicle weight (kg)	2245
	Kerb weight (min.-max.) (kg)	1785-1840
	Towing capacity with brakes (kg)	0
	Towing capacity without brakes (kg)	0

*Indicative charge figure, based on charger being used. Actual charging times may vary depending on various factors, including the age, type, condition and temperature of the charging unit and the battery, the starting charge and environmental conditions at the point of use. Charge times may be longer if battery temperature activates safeguarding technology.

[^]Official test values. Electric range figures are provided for comparability purposes; only compare electric range figures with other cars tested to the same technical procedures. These figures may not reflect real life driving results. Electric range can vary significantly depending on a number of factors, including the accessories fitted (post-registration), driving style, conditions, speed and vehicle load.

**Based on official test values. Official test values. Figures are provided for comparability purposes; only compare consumption figures with other cars tested to the same technical procedures. These figures may not reflect real life driving results. Electric range can vary significantly depending on a number of factors, including the accessories fitted (post-registration), driving style, conditions, speed and vehicle load.

UX 300e DIMENSIONS



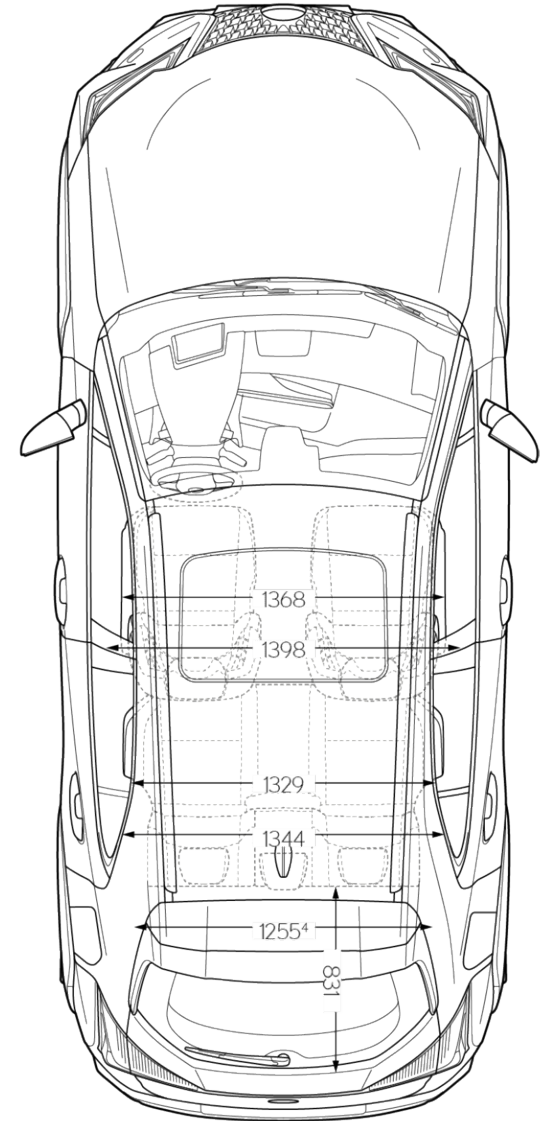
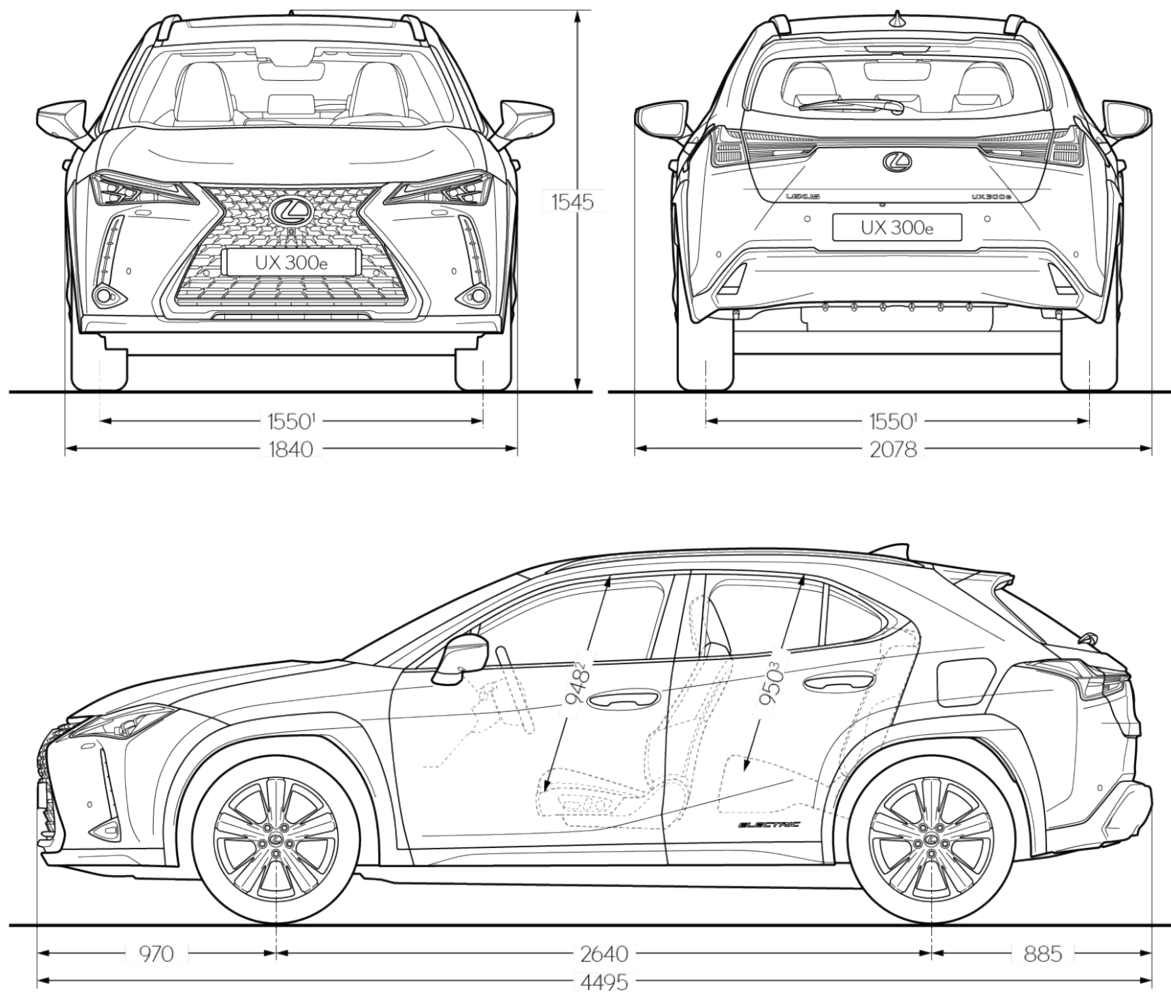

1. Vehicles with 225/50 R18 tyres. When specified with 215/60 R17 tyres, both front and rear track figures are 1560.

2. Figure quoted is for models specified with the standard roof. Equivalent figure for F SPORT models is 929. For models specified with the optional glass sunroof, the figure is 908 or 889 for F SPORT models.

3. Figure quoted is for models specified with the standard roof. Equivalent figure with the optional glass sunroof specified is 924.

Please note: the dimensions illustrated / noted are measured in millimetres.

LEXUS SUV RANGE



UX: HYBRID LUXURY COMPACT SUV

Combining the agility of a hatchback and strength of an SUV, UX is powered by fourth-generation Lexus Self-Charging Hybrid technology. Capable of travelling up to 71mph in electric mode, it has exceptional fuel economy and CO₂ emissions.

- 2-litre Self-Charging Hybrid
- 5 seats
- Front Wheel Drive (FWD) or E-FOUR All Wheel Drive
- Automatic transmission
- Luggage capacity: 320 litres (FWD); 283 (E-FOUR)

- Power: 184 DIN-hp
- MPG (l/100km) range: 47.0 (6.0) - 53.2 (5.3)
- CO₂ range: 137 - 120g/km

From £29,955



To learn more about the rest of the Lexus SUV range, please visit:

LEXUS SUV

4495mm

UX: ALL-ELECTRIC LUXURY COMPACT SUV

The UX 300e is spearheading the next chapter of electrification at Lexus. Created to evoke the original fun of driving in the city, the UX 300e combines world-class Lexus refinement with an exciting new full electric drivetrain to give a new Lexus Electrified experience.

- 150kW electric motor with 54.3 kWh battery
- 5 seats
- Front Wheel Drive (FWD)
- Single speed transaxle
- Luggage capacity: 367 litres

- Power: 150kW (204 DIN hp)
- Combined fuel economy (kWh / 100km): 17.1-16.
- Combined fuel economy (miles / kWh): 3.6-3.
- Range (miles): 196-190
- CO₂ range: 0 g/km

From £41,745



To learn more about the rest of the Lexus SUV range, please visit:

LEXUS SUV

4495mm

RX: HYBRID LUXURY SUV

A bold, emphatic exterior gives way to a world of unparalleled comfort, space and luxury. Equipped with our Self-Charging Hybrid technology RX delivers a seamless performance and exhilarating drive. Throughout you will discover useful features like Apple CarPlay®, Lane Tracing Assist, while the Lexus Safety System+ makes RX one of the safest SUV's out there.

From £52,665

To learn more about the rest of the Lexus SUV range, please visit:

LEXUS SUV

- 3.5 litre Self-Charging Hybrid
- 5 seats
- E-FOUR All Wheel Drive
- Automatic transmission
- Luggage capacity: 539 litres

- Power: 313 DIN-hp
- MPG (l/100km) range: 35.3 (8.0) - 35.7 (7.9)
- CO₂ range: 180 - 178g/km



4890mm

RX L: LARGE HYBRID LUXURY SUV

A family SUV that puts the focus firmly on luxury, RX L is elegant, spacious and engineered to make sure every passenger is pampered and protected. This versatile addition to our luxury SUV range features occasional 7 seats across three rows and enhanced cargo capability while still retaining the stylish figure and Self-Charging Hybrid that characterises RX SUV. The interior features a precision designed cabin and technologies such as Tri Zone Climate Control.

From £53,995

To learn more about the rest of the Lexus SUV range, please visit:

LEXUS SUV

- 3.5 litre Self-Charging Hybrid
- 7 seats
- E-FOUR All Wheel Drive
- Automatic transmission
- Luggage capacity: 591 litres with third row folded, 176 litres with third row up

- Power: 313 DIN-hp
- MPG (l/100km) range: 34.4 (8.2) - 34.4 (8.2)
- CO₂ range: 186 - 185g/km



5000mm

NX 350h: HYBRID LUXURY MID-SIZED SUV

NX is a pioneering mid-sized SUV that can be configured to match your lifestyle. Lexus Self-Charging Hybrid technology offers redefined performance and low emissions. Packed with intuitive technology, NX enhances your driving experience with beautifully finished interior, premium acoustics and Lexus Safety System+ as standard.

From: £38,300

To learn more about the rest of the Lexus SUV range, please visit:

LEXUS SUV

- Self-Charging Hybrid
- 5 seats
- E-FOUR All Wheel Drive
- Automatic Transmission
- Luggage capacity: 521 litres

- Power: 242 DIN/hp*
- MPG (l/100km) range: 44.1 (6.4)*
- CO₂ range: 133-146*



4660mm

NX 450h+: HYBRID LUXURY MID-SIZED SUV

The NX is a pioneering mid-sized SUV that can be configured to match your lifestyle. Lexus Plug-in Hybrid technology offers a dynamic yet efficient driving experience. Packed with intuitive technology, the NX enhances your driving experience with beautifully finished interior, premium acoustics and Lexus Safety System+ as standard.

From: £48,800

To learn more about the rest of the Lexus SUV range, please visit:

LEXUS SUV

- Plug in Hybrid
- 5 seats
- >40 miles electric range
- E-FOUR All Wheel Drive
- Automatic Transmission
- Luggage capacity: 521 litres

- Power: 306 DIN/hp*
- MPG (l/100km) range: 256.8 (1.1)*
- CO₂ range: 20-26*



4660mm

HAVE YOU CONSIDERED A SELF-CHARGING HYBRID?



Since the introduction of the Lexus Self-Charging Hybrid RX 400h in 2005, Lexus has pioneered the electrification of the Premium market. We also offer a range of hybrid cars and SUV that can be in EV mode for up to 52% of travel time. These offer a compelling alternative if a full EV is not quite the right vehicle for your lifestyle.



*Average percent of 7,805 UX 250h test drives taken up to 13th March 2020. Figure accurate as of 13th March 2020. Our hybrid demonstrator vehicles are fitted with a telematics device, which with your permission will track your test drive journey to gather key statistics and show you how efficient your drive is. Hybrid test drive data is retained for a maximum of one year and is for statistical and research purposes only. Only Lexus GB and DriveCo (the service provider) will have access to this information.

TERMS & CONDITIONS



ADDITIONAL BENEFITS

3 YEARS' FREE LEXUS ROADSIDE ASSISTANCE

Whatever the situation, when you're driving your Lexus, we're just one call away with expert support at the roadside 24 hours a day, every day of the year. Free for 3 years from the initial purchase of a new vehicle, 24 hours a day, 365 days a year, assistance anywhere in the UK.

HOME START

One in four breakdowns happen at the home address. Home Start allows you to enjoy all the benefits of Lexus Roadside Assistance from your home address.

PERSONAL ASSISTANCE

Lexus Roadside Assistance is designed to look after you – not just your vehicle. So even if you are a passenger in someone else's car you can still receive Lexus Roadside Assistance.

REPLACEMENT VEHICLE

A replacement vehicle will be provided free of charge (excluding petrol and other consumables) for up to three days, provided we have taken your vehicle to a Lexus Centre for repairs following a breakdown.

HOTEL ACCOMMODATION

If a replacement vehicle is unavailable, we will arrange a hotel for

you and your family for up to £150 per person to a maximum of £500, for one night.

ONWARD TRAVEL

If a replacement vehicle is unavailable and you would like to make your own travel arrangements following a breakdown, we will reimburse the cost of this up to £150 per person, to a maximum of £500.

EUROPEAN TRAVEL

If you travel across Europe your Roadside Assistance will travel with you, whether you are driving your Lexus or another car.

MEDICAL ASSISTANCE

If the driver of the car is certified ill, we will take you and your passengers to any single destination in the UK.

LOST OR BROKEN KEYS

If you lose or break your keys, Lexus Roadside Assistance will arrange for recovery of your vehicle to a local Lexus Centre. You will be responsible, however, for the cost of replacement keys.

EV BATTERY HEALTH CHECK

EV CHECK

An annual check at your local LEXUS Authorised Repairer is the best way to ensure you are getting the most from your EV.

EXTENDED EV CARE

From new, all EV components benefits from our five-year/60,000* miles warranty. When your vehicle is brought in for its annual health check it will be eligible for a further one-year/10,000** miles of EV battery extended care up to 10 years old/600,000 miles** for degradation below 70% of initial capacity. Having created the Lexus EV technology, only a LEXUS EV Authorised Repairer can give you the peace of mind and expert care you expect.

*whichever comes first, first year unlimited

**whichever comes first

TERMS & CONDITIONS

Vehicles in the Lexus range come with high specifications as standard. As a result, the 'on the road' price* includes not only all those items generally offered as extras, but also many advanced features exclusive to Lexus. Details of the extensive technical specifications and interior appointments of each model are described fully in the main brochures. Whichever model you choose, you can look forward to a standard of After Sales service that's second to none, provided by a network of Lexus Centres individually selected for their exemplary record in customer care. Some Lexus vehicles (including certain specifications and colour/trim combinations) are built to order and could take approximately 2 to 3 months from time of purchase to delivery. For detailed information on lead times, please consult your local Lexus Centre.

WARRANTIES

MANUFACTURER WARRANTY

3 Years/ 60,000 miles comprehensive warranty.

Any defect that is attributable to a manufacturing or an assembly defect under normal use is covered by your warranty. This provision applies for a period of 3-years or 60,000 miles, whichever comes first, with no mileage limit for the first year. In the event of a breakdown immobilising your Lexus, the cost of recovering it to the nearest Lexus Centre is also covered if that breakdown is the result of a warrantable defect.

LEXUS RELAX

Up to 10 Years /100,000 mile Lexus warranty.

Every new Lexus, is eligible to be covered by up to 10 years' manufacturer warranty through Lexus Relax. This is provided through an initial 3 years manufacturer warranty that can be extended with regular servicing at a Lexus Centre. A 12 months' warranty is included with every Lexus Service, up to 100,000 miles or 10 years, whichever comes first, giving you a chance to relax in the knowledge that you and your vehicle are in safe hands. Terms and conditions apply. For full details, please ask your official Lexus Centre, visit lexus.co.uk/lexus-relax/terms or search Lexus Relax.

HYBRID VEHICLE WARRANTY

5 Years / 60,000 miles hybrid component warranty.

For hybrid models, certain components within the hybrid drivetrain

system have a 5 years or 60,000 miles warranty, whichever comes first. For more information please contact your local Lexus Centre.

3 YEARS SURFACE RUST AND PAINTWORK WARRANTY

This warranty offers three years of cover for surface rust and paint defects appearing on any of the painted body panels due to a fault in material or workmanship. There is no mileage restriction on this.

12 YEARS CORROSION PERFORMANCE WARRANTY

A 12-year unlimited mileage warranty covers the vehicle against rust perforation through any sheet metal body panel (subject to certain exclusions specified in the warranty booklet) occurring as a result of a manufacturing or assembly defect in the vehicle. The warranty booklet supplied with each new vehicle gives full details. This warranty is also transferable to subsequent owners.

SERVICE PLANS

Service plans are a flexible way of managing the cost of servicing your Lexus. With a service plan you can ensure that your vehicle is maintained to the standards you would expect from Lexus-trained technicians fitting the highest quality Lexus parts**. Please contact your local Lexus Centre for a quote.

QUOTED CO₂ AND POWER USAGE FIGURES

†Figures are provided for comparability purposes; only compare fuel consumption, CO₂ and/or electric range figures with other cars

tested to the same technical procedures. These figures may not reflect real life driving results. Fuel consumption, CO₂ produced and electric range can vary significantly depending on a number of factors, including the accessories fitted (post-registration), driving style, conditions, speed and vehicle load.

All models and grades are certified according to the World Harmonised Light Vehicle Test Procedure (WLTP). More information can be found by visiting: <http://www.vehicle-certification-agency.gov.uk/fcb/wltp.asp>

LEXUS FINANCIAL SERVICES

Lexus Financial Services offers an extensive range of finance products, including Lexus Connect – Contract Purchase, Lexus Connect Personal Contract Purchase and Lexus Connect – Contract Hire. Products that offer a combination of benefits designed to make acquiring a Lexus as easy as driving one.

Whether you are a private motorist looking for the most flexible, affordable options or a business wishing to boost cash flow and tax-efficiency, our finance products provide attractive, refined solutions.

Your Lexus Centre will be happy to discuss the full range of financing options available and create a finance quotation that is right for you. When you choose to go ahead your Lexus Centre will arrange your application. Delivering complete customer satisfaction underpins everything we do at Lexus, so once you commence an agreement with us, you can rest assured that our team of UK-based customer service representatives are only a phone call away if you have any queries. **Finance Subject to status to over 18s.**

Indemnities may be required. T&Cs apply.

*'On the road' price comprises list price, £700 delivery charge, £26 number plate allowance (all inclusive of VAT) plus 12 months Vehicle Excise Duty (variable, depending on model) and £55 Vehicle First Registration Fee.

**The service plans exclude cambelt/timing chain changes.

To discover more about Lexus UX 300e:

[VIEW FULL BROCHURE](#)

Learn more about Lexus UX 250h

[VIEW FULL BROCHURE](#)

To learn more about the rest of the Lexus SUV range

[VISIT THE LEXUS WEBSITE](#)

Reserve your New UX 300e online and be the first to experience our new electric car.

Once you've placed your £1,000 reservation fee, you'll receive an exclusive invitation to finalise your order details with your preferred Lexus Centre.

[RESERVE ONLINE](#)

[FIND A CENTRE](#)

UX

SIGN UP TO NEWSLETTER - UX 300e

To be the first to hear about the latest new updates on UX 300e and receive information on our latest Lexus news, offers and events, simply fill in your details in the form on the right, and we'll add you to our mailing list.

We'd like to keep you updated on our latest news, offers and events. We will send these communications by email, phone, SMS or post. Be assured that Lexus UK will only share your personal information with companies that are an integral part of fulfilling the services we deliver. If you would like to find out more about how we process your data please visit our [privacy policy](#) for details.